

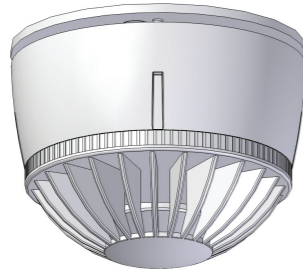

# 116-BBQ-130 116-BBR-130



EN54-3 Fire Alarm Device - Sounder  
 Dispositif d'alarme incendie EN54-3 – Avertisseur d'incendie  
 EN54-3 Feueralarmgerät – Töner  
 Dispositivo di allarme antincendio a norma EN54-3 - Sirena  
 EN54-3 Brandalarm – sounder  
 Dispositivo de alarma de incendios EN54-3 – Timbre de alarma  
 EN54-3 Brandvarnare – Signalgivare  
 EN54-3 Urządzenie systemów SAP - Sygnalizator

	116-BBR-130	116-BBQ-130
	17 ~ 25VDC	
	LP - 2.2mA HP - 4.4mA	Strobe - 4.7mA* Peak Current - 8.7mA
	0.5mm <sup>2</sup> ~ 2.5mm <sup>2</sup>	
	-10°C ~ +55°C (-15°C ~ +70°C**)	
	ABS / PC	
	Type A / IP22**	
	NA	1Hz***

Product exceeds minimum requirements of EN54-3 & EN54-17  
 Le produit dépasse les exigences minimum de EN54-3 & EN54-17  
 Das Erzeugnis erfüllt die Mindestanforderungen von EN54-3 & EN54-17  
 Il prodotto supera i requisiti minimi previsti dalla norma EN54-3 & EN54-17  
 Product overtreft de minimale vereisten van EN54-3 & EN54-17  
 El producto excede los requisitos mínimos de la norma EN54-3 & EN54-17  
 Produkten överträffar minsta krav enligt EN54-3 & EN54-17  
 Parametry techniczne produktu przekraczają minimalne wymagania normy PN EN54-3 & EN54-17

\*See 116-BBR-130 for Sounder only current  
 Isolator Specification ref: 082/4.2/005 Rev 1.3

\*\*Non EN54 certified, verified during additional marine testing.  
 \*\*\*The beacon is for supplementary indication only.  
 Do not use where a EN54-23 compliant VAD is required.

Supplier / Customer Support  
 Autronica Fire and Security  
 N-7483 Trondheim, Norway  
 See Website - [www.autronicafire.no](http://www.autronicafire.no)

Detailed EN54-3 Polar SPL Measurement are available in AFS doc BB-212  
 Les mesures NPA polaires détaillées EN54-3 sont disponibles dans BB-212  
 Detaillierte Polar-SPL-Messungen gemäß EN54-3 sind erhältlich in BB-212  
 Le misurazioni SPL polari ai sensi della norma EN54-3 sono disponibili in BB-212  
 Uitgebreide polaire SPL-afmetingen voor EN54-3 zijn beschikbaar in BB-212  
 Las medidas detalladas del SPL polar EN54-3 están disponibles en BB-212  
 Detaljerade polära mätningar av ljudtrycket enligt EN54-3 finns under BB-212  
 Szczegóło pomiarów kątowych SPL wg EN54-3 dostępne są w BB-212

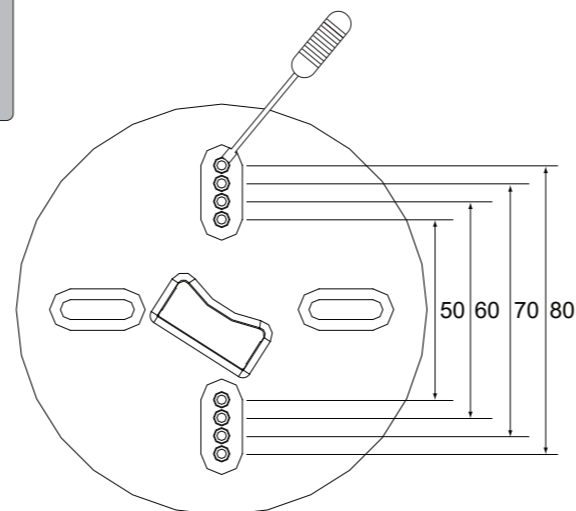
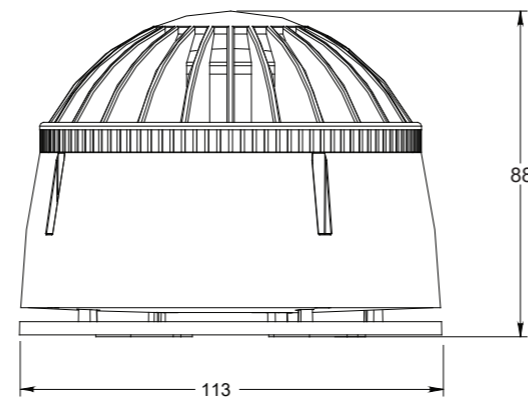
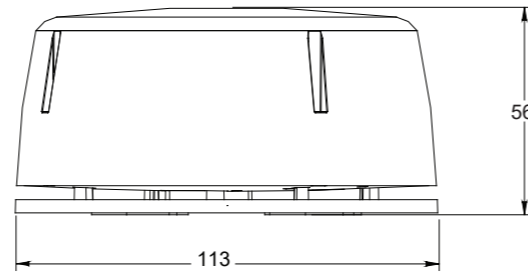
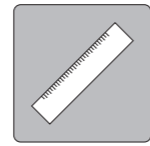

**Note : Knock out ONLY required fixing holes**

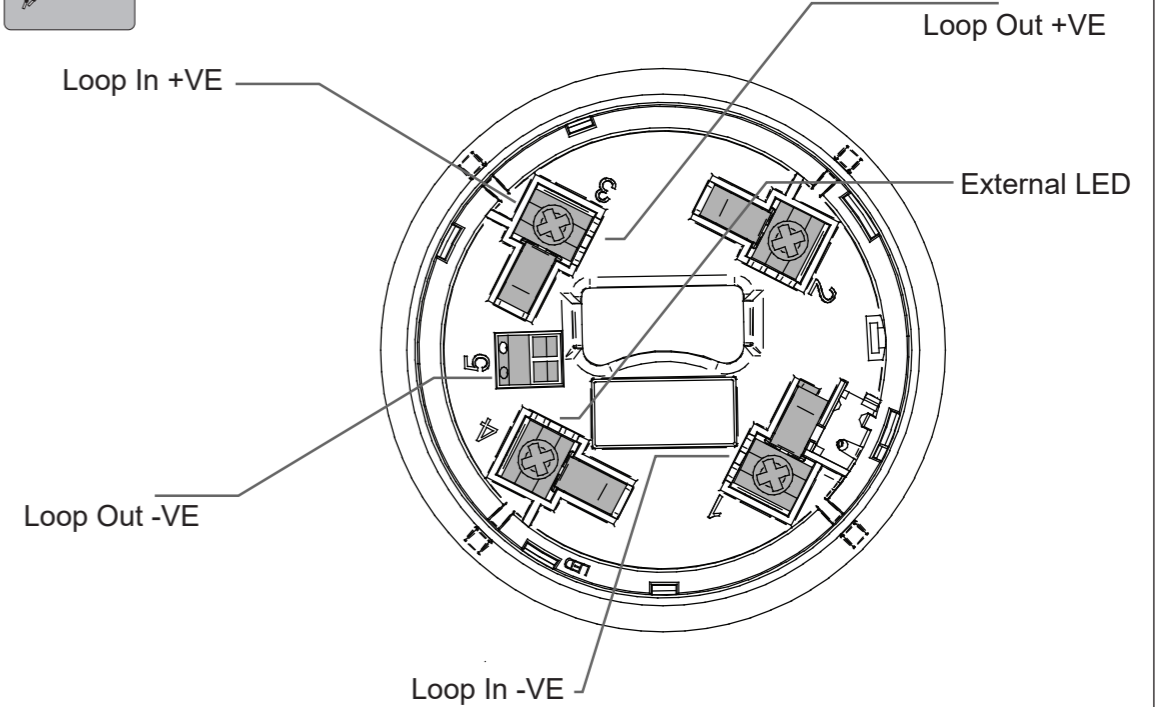
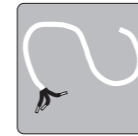

### Tones Table

NO	Standard pattern
1	General Alarm (800Hz, 1,0 sec pulse & 3,0 sec)
2	Evacuate (880Hz, 1,0 sec on/ 1 sec off, forever)
3	Alert (880Hz 0,5 sec on, 3,5 sec off)
4	Bell Test (0,5 sec on every 8 sec)

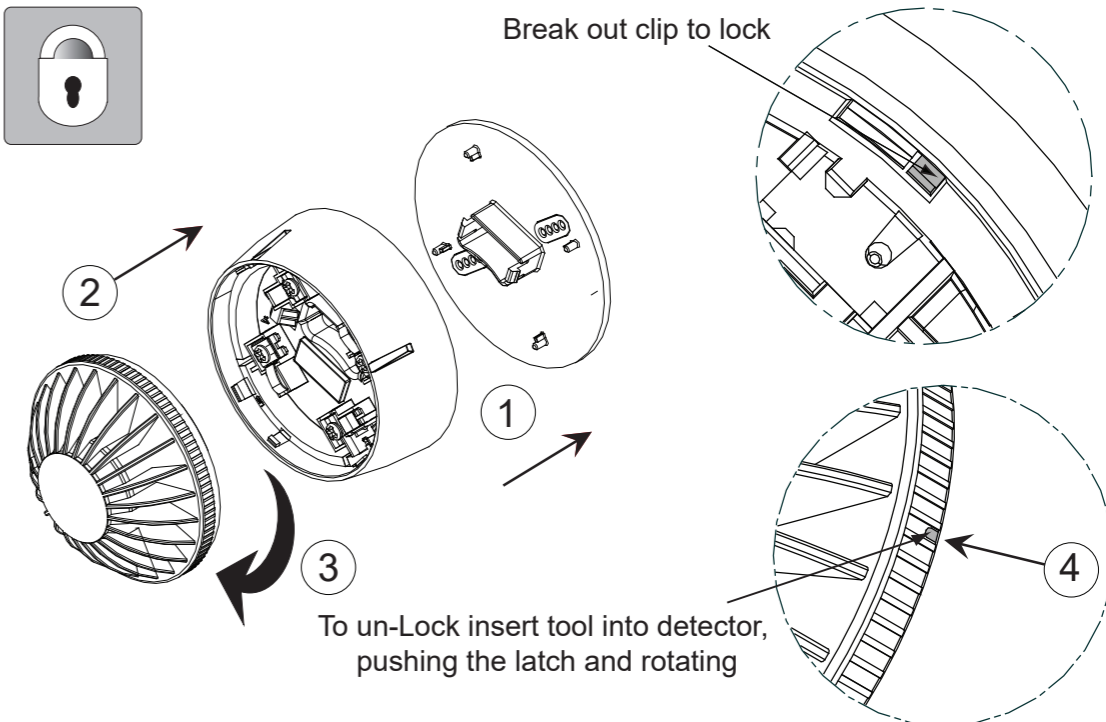

Manufacturer. Eaton Electrical Products Ltd  
 Cwmbran, S. Wales. UK - [www.eaton.com](http://www.eaton.com)

25-9441-G